

klokers

User manual

KLOK-08

BASIC FUNCTIONING

Two concentric discs turn counterclockwise. A colored vertical axis on the top of dial (patent-pending) indicates the time.

MODE DISPLAY

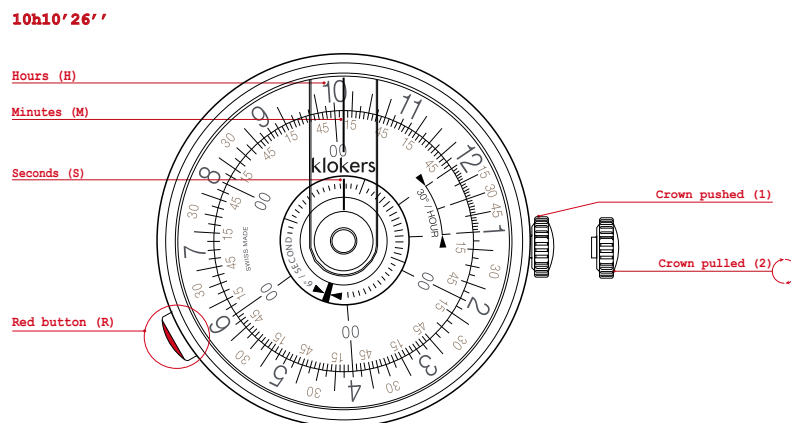

TIME SETTING

1. Pull the crown out to position (2).
2. Set the time using the crown.
3. Push the crown back to position (1).

GOOD TO KNOW

- Pulling the crown out to position (2) stops the movement.
- It is essential to set the time by turning the disc counterclockwise. This will ensure a good time setting.

klokers

User manual

CLIP/REMOVE THE WATCH HEAD FROM THE BRACELET

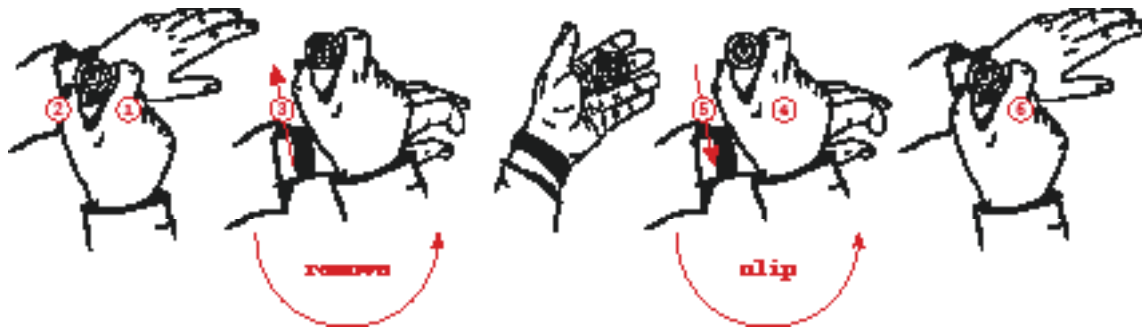

REMOVE THE CASE FROM THE BRACELET

1. Hold firmly the watch head in your hand
2. Push the button at 8 o'clock to position (4) to unlock the mechanism
3. Holding the button, slide the watch head up to unlock it from the bracelet (or any other accessory)

CLIP THE CASE TO THE BRACELET

4. Hold firmly the watch head in your hand
5. Slide the watch head from top to bottom on the Key of the bracelet (or any other klokers accessory)
6. Push the watch-head until a click is felt. Only this click will guarantee that the watch-head is correctly clipped on the bracelet.

ALL THE KLOKERS' PRODUCTS ARE INTERCHANGEABLE WITH EACH OTHER!

⚠ Warning: handle the watch head with care and be sure you hold it firmly while unlocking it from its support to not drop it. klokers is not responsible in case of a fall during this manipulation.







klokers

User manual

CHARACTERISTICS

THE CASING

- The klokers's Key: a pushbutton at 8 o'clock to unlock the watch head from its base
- Material: metal-polymer composite
- Dimensions: 44 mm wide x 11,5 mm deep
- Water Resistant (splashproof)

					
Rain splash	Hand washing	Shower	Bath	Swimming	Diving
●	●	●	●	●	●
YES	YES	NO	NO	NO	NO

- Assembly: partially non-dismantable technical construction
- Glass: transparent decorated polymer with built-in magnifying lens

RETARDED/ADVANCED TIMING

- Less than 3, more than 1 minute (monthly average)

MOVEMENT

- Swiss Made
- Driven by a high-tech Ronda movement (high precision Quartz movement)
- Displaying the rotary discs is made possible thanks to the use of extremely energy efficient movement

BATTERY

- 1,5 V battery, standard 364

DISPLAY

- Alignment tolerance of discs (H) and (M) + / - 2 minutes

AUTONOMY

- About 16 months

GUARANTEE

- Two-year warranty against all production defects (See the guarantee given at time of purchase)

USAGE PRECAUTION

Your watch comes with its blue static protections. Remove them before considering any use of the watch (glass, watch case-back, the klokers' key, etc...), otherwise the closing system (watch-case and bracelet) may be damaged.

To set the time on KLOK-08, you must always use the crown counterclockwise (the three discs must imperatively turn counterclockwise).

Be sure to constantly protect the push button from any impact or pressure that could unlock the watch-head.

When manipulating your watch and removing it from the klokers' accessories, be sure to firmly hold the watch-head.

Please be sure to handle your klokers with care, taking care not to drop, knock or crash the watch head. The movement could be irreversibly damaged.

klokers

User manual

WARNING

Each watch having an impact or trace of shock on the glass or on the middle of watch-case will not be covered by the guarantee.

Do not try to dismantle or modify the watch.

Do not remove the battery from the watch: battery replacement requires special knowledge and professional expertise.

Please contact a person working in the shop where your purchased your watch.



Keep your KLOK-08 away from any electro magnetic sources



Please do not use your KLOK-08 when playing sports (golf, tennis..) or during any other activities that may create vibrations, shocks, brutal accelerations and decelerations



Keep out of reach of babies and children.



Do not put your klokers under clear water. The pressure of normal tap water may decrease waterproofness performance of a watch conceived for the everyday life



Remove the watch before taking a bath or going into the sauna. Do not turn or pull the crown when the watch head is wet, the water could penetrate the watch. If the inner surface of the glass is fogged, or if water drops appear inside the watch, this means waterproofness has been diminished. Immediately contact the retailer where you have purchased the watch.

Keep in mind waterproofness of a watch can be diminished by the deterioration of the adhesive of the glass or the seal, or by rust formation on stainless steel parts. Steam, soap, or some components of a heat source can accelerate waterproofness degradation.



Avoid wearing the watch or store it in the following places: places in which volatile agents are sprayed (cosmetic products such as solvents, insecticides, paint solvents, etc.), places in which temperature remains below +5 °C or above 35 °C for a long time; very damp places; places affected by a powerful magnetic field or static electricity; dusty places; places affected by strong vibrations.

Do not put in contact with acid, acetone or any other chemical product. In case of contact, immediately rinse with cold water to minimise the impact.

Stop wearing the watch immediately if the case or the bracelet is affected by corrosion.

If you notice any symptoms of allergy or skin irritation, stop wearing the watch immediately and consult a dermatologist or an allergist.